







**Parts List & Hardware List**

Parts List			QTY
A	CHAIR BACK & SEAT		1 pc
B	CHAIR BASE		1 pc

Hardware List			QTY	Hardware List			QTY
1	ALLEN BOLT	 1/4"*1"L	4 pcs	3	FLAT WASHER	 1/4"	4 pcs
2	LOCK WASHER	 1/4"	4 pcs	4	ALLEN WRENCH	 4mm	1 pc

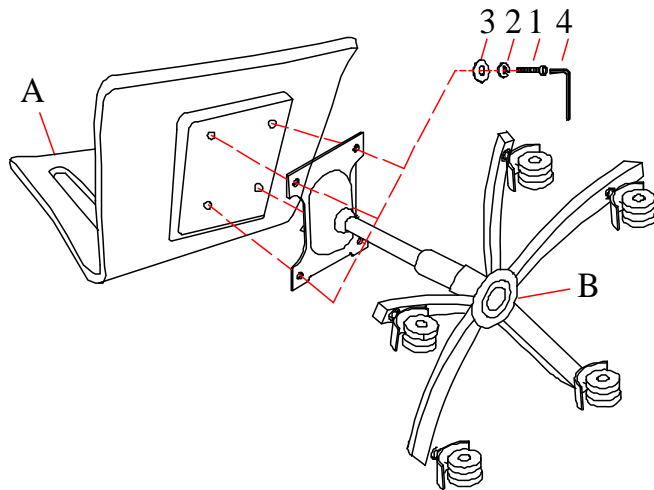

STEP 2

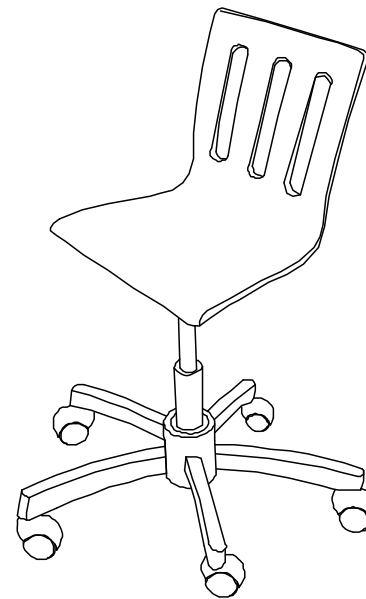

STEP 3

**Assembly Procedures:**

- Step 1: Lay out all parts and hardware. Make sure the quantity of each is correct.
- Step 2: Assemble the chair base (B) to the stretcher (A) with the hardware provided.
- Step 3: Turn the chair upright.

**Assembly is now complete.**