

**WARNING:**

Do not use this crib if the enclosed or attached instructions cannot be strictly adhered to. Do not use this crib if the child is able to climb out unaided or is taller than 90 cm. Do not place cords, straps or similar items that could become wound around the child's neck in or near this crib. The mattress used with this crib should not be more than 15 cm thick and should be of such length and width that the gap between the mattress and the sides of the crib is not more than 3 cm when the mattress is pushed into the corner of the crib.

09-004

**WARNING:**

Failure to follow these warnings and assembly instructions could result in serious injury or death.

- Read all instructions before assembling crib. KEEP INSTRUCTIONS FOR FUTURE USE.
- Before each usage or assembly, inspect crib for damaged hardware, loose joints, missing parts or sharp edges. DO NOT use crib if any parts are missing or broken. Telephone or write to Legacy Classic Kids for replacement parts and instructional literature if needed. DO NOT substitute parts.
- DO NOT use a water mattress with this crib.
- DO NOT place crib near window where cords from blinds or drapes may strangle a child.
- When child is able to pull to standing position, set mattress to lowest position and remove bumper pads, large toys and other objects that could serve as steps for climbing out.
- Infants can suffocate on soft bedding. Never add a pillow, comforter, or padding.
- If refinishing, use a non-toxic finish specified for children's products.
- Never use plastic shipping bags or other plastic film as mattress covers because they can cause suffocation.
- Strings can cause strangulation! Do not place items with a string around a child's neck, such as hood strings or pacifier cords. Do not suspend strings over a crib or attach strings to toys.
- To help prevent strangulation, tighten all fasteners. A child can trap parts of the body or clothing on loose fasteners. Infants can suffocate in gaps between the crib sides and a mattress that is too small.
- To reduce the risk of SIDS, pediatricians recommend healthy infants be placed on their backs to sleep, unless otherwise advised by your physician.
- When child is able to climb out or reaches the height of 35 inches (90 cm), the crib must be replaced with a Toddler Bed or larger bed

09-005



CAUTION: ANY MATTRESS USED IN THIS CRIB MUST BE AT LEAST 27 ¼” (69 CENTIMETERS) BY 51 5/8” (131 CENTIMETERS) WITH A THICKNESS NOT EXCEEDING 6” (15 CENTIMETERS) BUT AT LEAST 4” (10 CENTIMETERS).

THIS CRIB CONFORMS TO APPLICABLE REGULATIONS PROMULGATED BY THE CONSUMER PRODUCT SAFETY COMMISSION

09-003

IMPORTANT SAFETY INSTRUCTIONS:

- Please carefully read all instructions and warnings before assembling the crib.
- Use only vendor’s supplied hardware to assemble. Using unauthorized hardware could jeopardize the structural integrity of the item.
- For your safety and ease, assembly by two or more adults is recommended.
- Keep instructions for future use.

PARTS INCLUDED:

(A) Left Side Gate - 1 pc

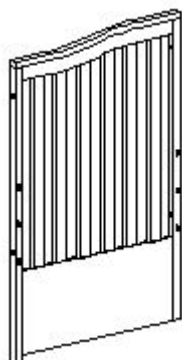

(B) Right Side Gate - 1 pc

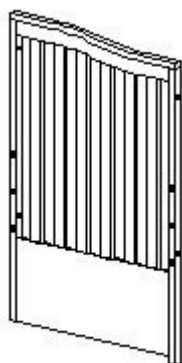

(C) Mattress Metal Base - 1pc

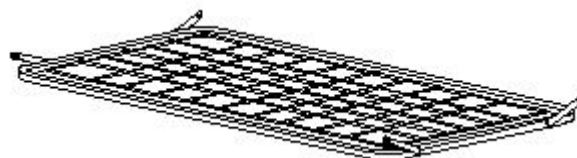

(D) Crib Back Head Board – 1pc

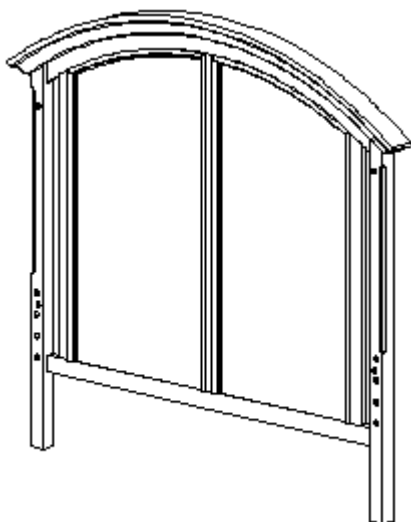

(E) Front Gate Foot Board- 1

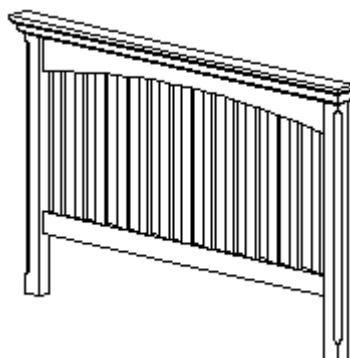

HARDWARE ENCLOSED:

(F) Hex bolt screws: M6 x 40 – 8pcs

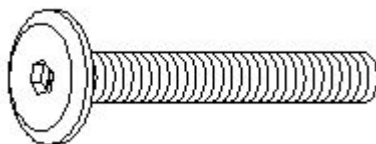

(G) Bottom head bolt M6 x 16 – 4pcs

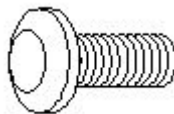

NOTE: Store all hardware out of child's reach.

TOOLS REQUIRED:

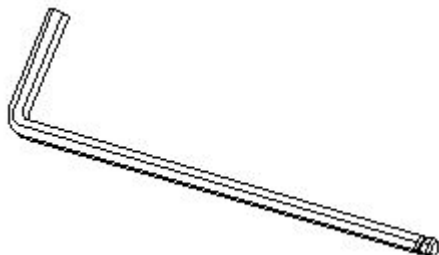

(H) Hex Allen Wrench with Ball tip -1pc (included)

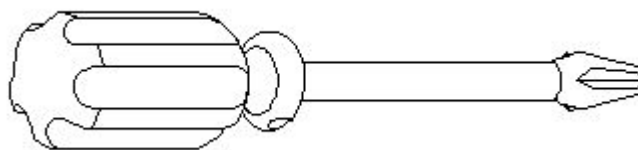

Phillips Screwdriver (not included)

PRE- ASSEMBLY:

- Remove all parts and hardware from the box and lay out on a clear carpeted or scratch-free work surface, as this will avoid damaging parts during assembly. The shipping box provides an ideal work surface.
- Do not dispose of any packaging or contents of the shipping carton until assembly is completed to avoid accidentally discarding small parts or hardware.
- Use the parts and hardware lists above to identify and separate each of the pieces included.
- The illustrations provided allow for easier assembly when used in conjunction with the assembly instructions.
- The use of power tools for assembly is not recommended. Power tools can damage hardware or split wood.

ASSEMBLY INSTRUCTIONS:

1. Remove the assembly instructions from the envelope attached to the Crib and review. Keep them handy for referring to the part and hardware descriptions
2. Assemble the Left Side Gate (A) and Right Side Gate (B) to the Mattress Metal Base Brackets (C) with 4 Bolts (G) using the Hex Allen Wrench (H). Adjust the brackets of the Mattress Metal Base (C) to fit the hole of Side Gate once assembling (See Fig 1)

NOTE: The Mattress support base may be at the highest level when the child is born. It must be at the lowest level by the time the child can stand up.

Fig (1)

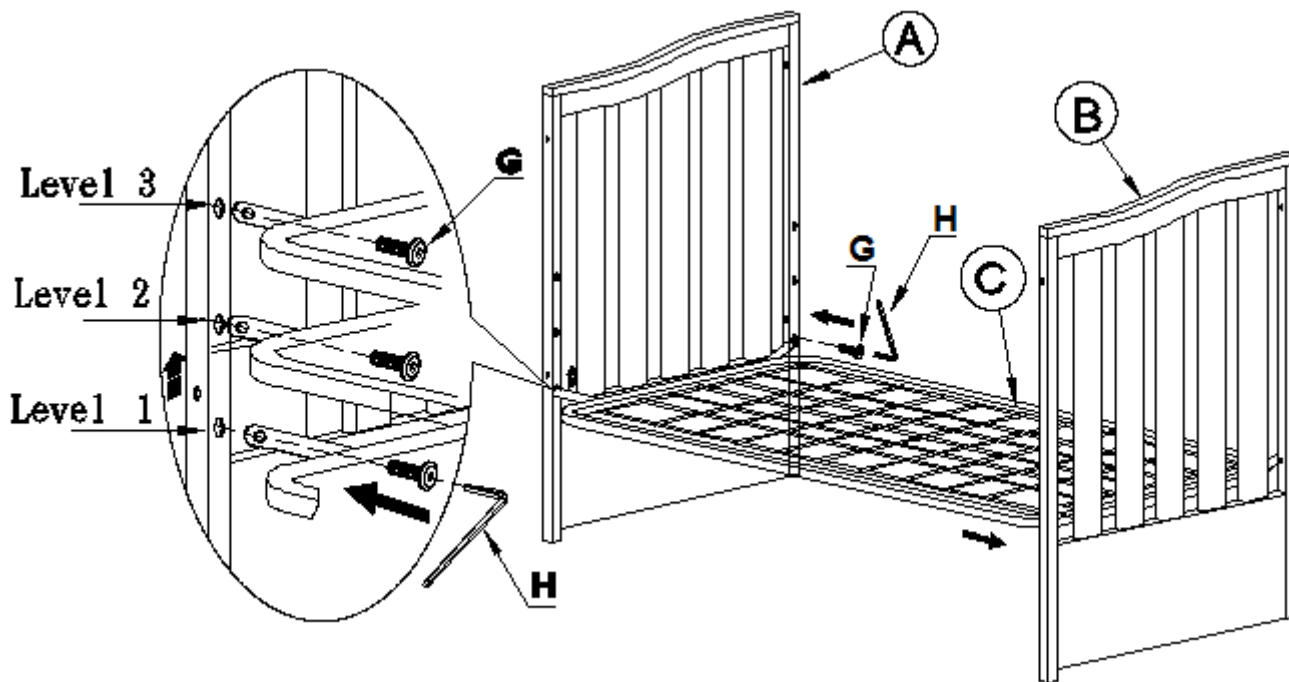

3. To change the position of the Mattress Metal Base (C), unscrew the 4 bolts (G), line up the Mattress Metal Base (C) with the holes at the desired height and re-attach the Mattress Metal Base (C) with the same bolts (G).
4. Assemble the Crib Back (D) to the Left Side Gate (A) and to the Right Side Gate (B) with 4 Bolts (F), using the Hex Allen Wrench (H) (see Fig 2).

Fig (2)

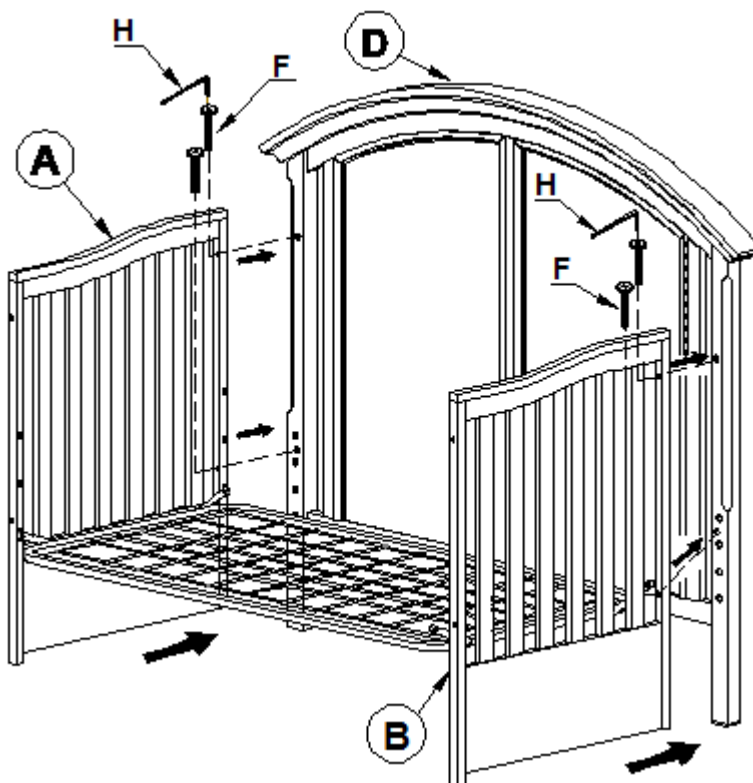

4. Assemble the Front Gate (E) to the crib using 4 same Bolts (F). Tighten using the Hex Allen Wrench (H). (See Fig 3)

Fig (3)

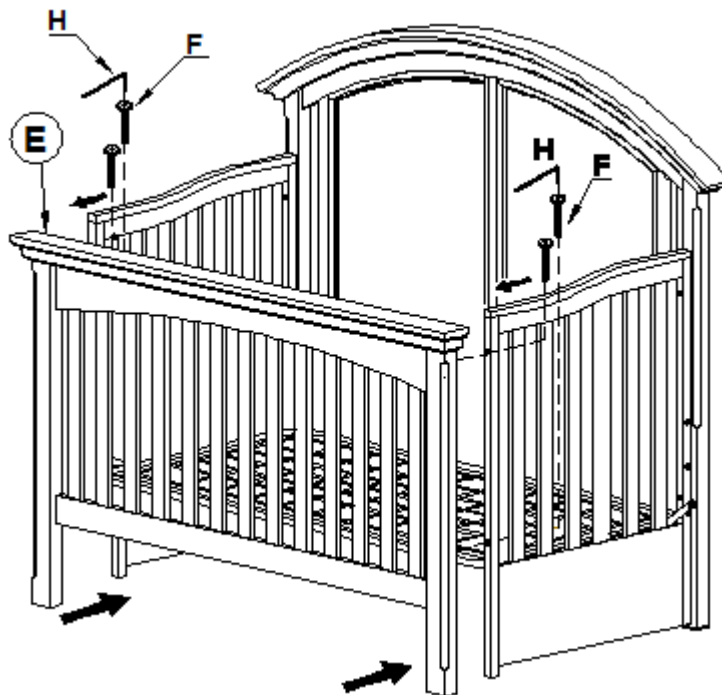

5. Tighten all connections. Assembly is complete.

Fig (4)



NOTE:

- As this Crib is designed to grow with your child, please retain these instructions as well as all hardware for future use. Always keep all small parts and hardware out of children’s reach.
- With the addition of this Crib Conversion Kit (sold separately), your Legacy Classic crib will become a Toddler Bed/Daybed. Please see the Assembly Instructions included with the Legacy Classic Toddler Bed/Daybed for details

CARE INSTRUCTIONS

- Dust often using a clean, soft, dry lint-free cloth.
- Blot spills immediately, and wipe with a clean, damp, cloth.
- We do not recommend the use of chemical cleansers, abrasives, or furniture polish on our lacquered finish.
- If the crib is to be stored, store in cool dry place and carefully package all original hardware to protect from loss or damage.
- Check fasteners periodically for tightness. **DO NOT over tighten.** This may cause distortion or breakage

This Crib can be converted to a Full Size Bed with the purchase of Legacy Classic Bed rail. You will be provided 4pcs flat head bolt M6 x 15, 8pcs bolt M6 x 76mm, to attach the Bed rail into your Crib. Follow the instruction below with two adults:

PARTS INCLUDED:

(R) Flat head bolts M6 x 15 – 4pcs

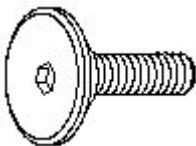

(Q) Hex bolt screws: M6 x 76 – 8pcs

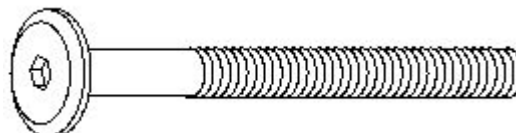

ASSEMBLY INSTRUCTIONS:

1. Disassemble your Crib or Toddler Bed/Daybed and set all pieces and hardware aside in an organized manner.
2. Keep the Headboard and the Footboard upright.
3. Assemble the Side Rail to the Headboard and the Footboard with 8 bolts (Q). To change the position of the side rail, unscrew 4 bolts (Q), line up the Side rail with the holes at the desired height and re-attach the Side rail with the same bolts (Q).
4. Insert the flat head bolts (R) into the upper hole of the Headboard and the Footboard to keep out of the children's reach
5. Tighten all connections. Assembly is complete.

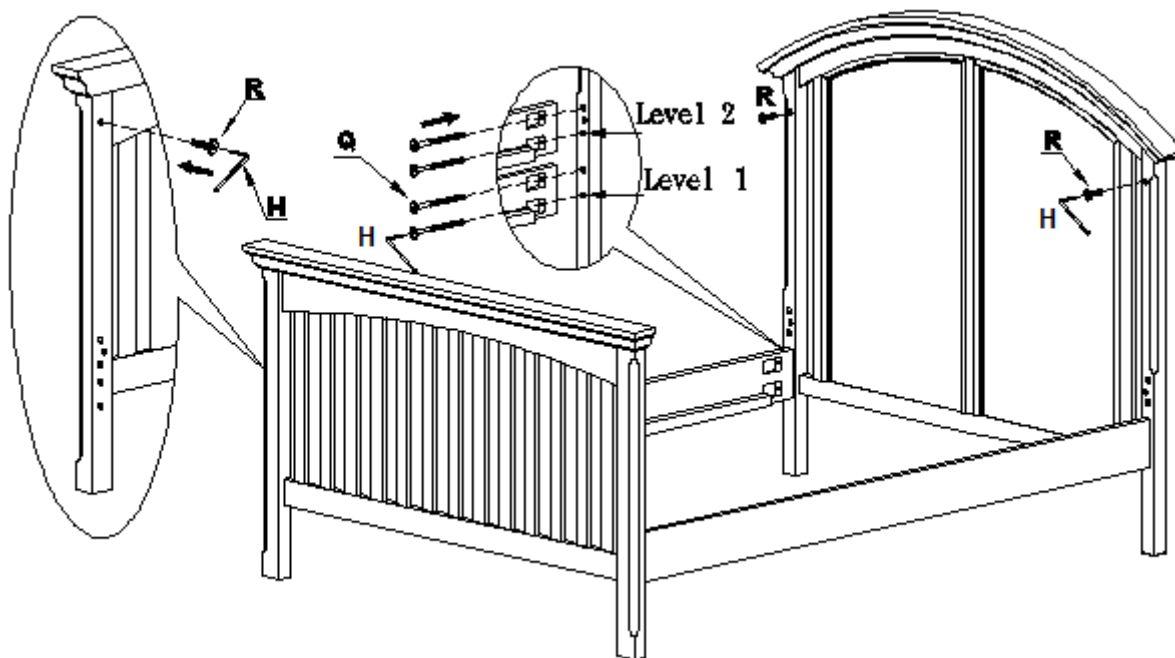

THANK YOU FOR YOUR PURCHASE.

www.legacyclassickids.com

High Point, NC. 336 449 – 4600